

UNTIY

C05B0804. / C05B0805.

Installation Instruction

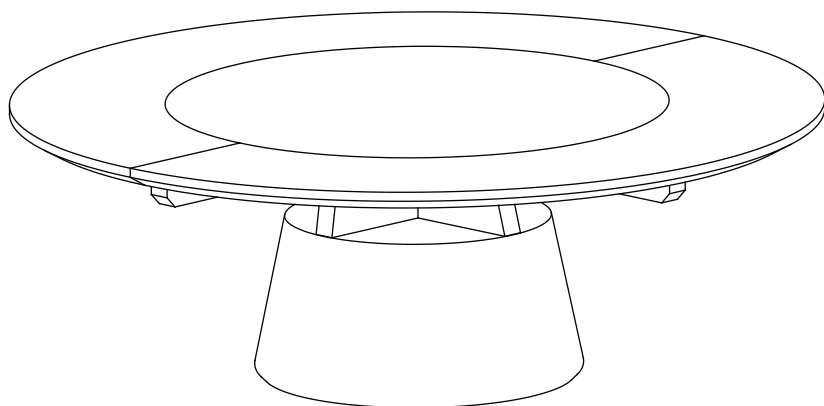

CAMERICH

C05B0804.

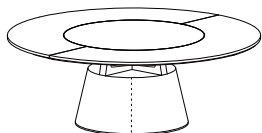

C05B0805.

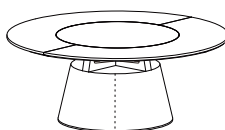

M8X80mm

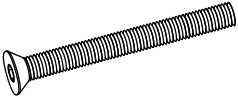

8X

M8X30mm



16X

M8X30mm

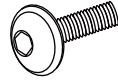

32X



4X

D26mm

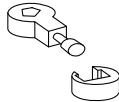

4X

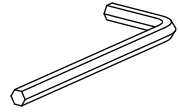

M5

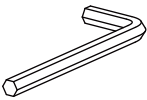

M6

