

CHARM

C07E0401.

Installation Instruction

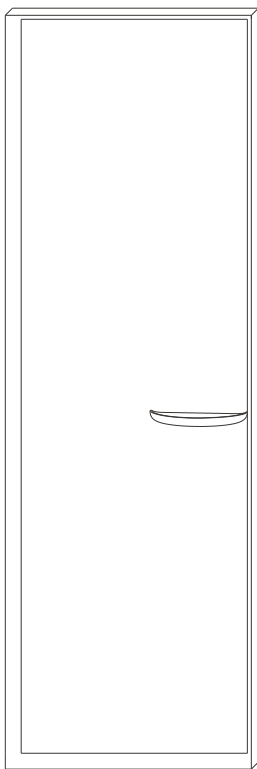

CAMERICH

M6X30mm

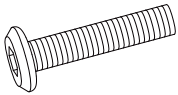

2X

M6X25mm

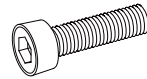

2X

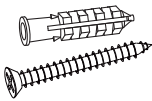

3X

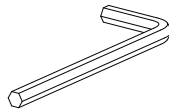

M5

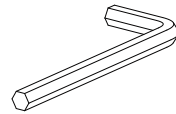

M6

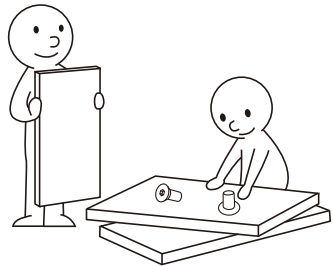
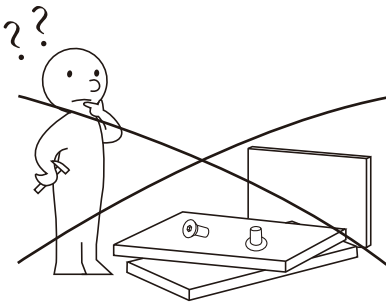
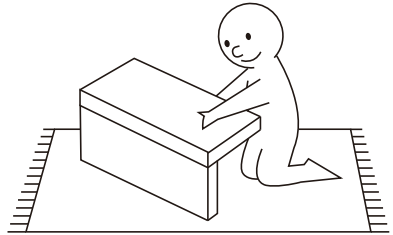
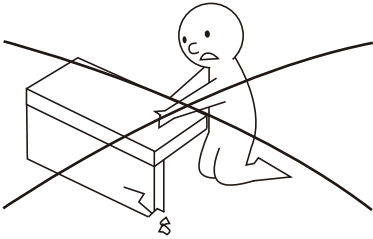
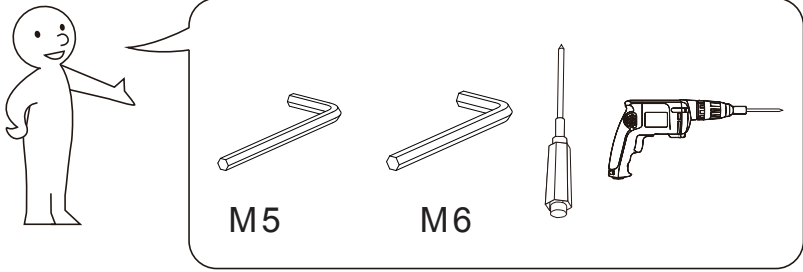

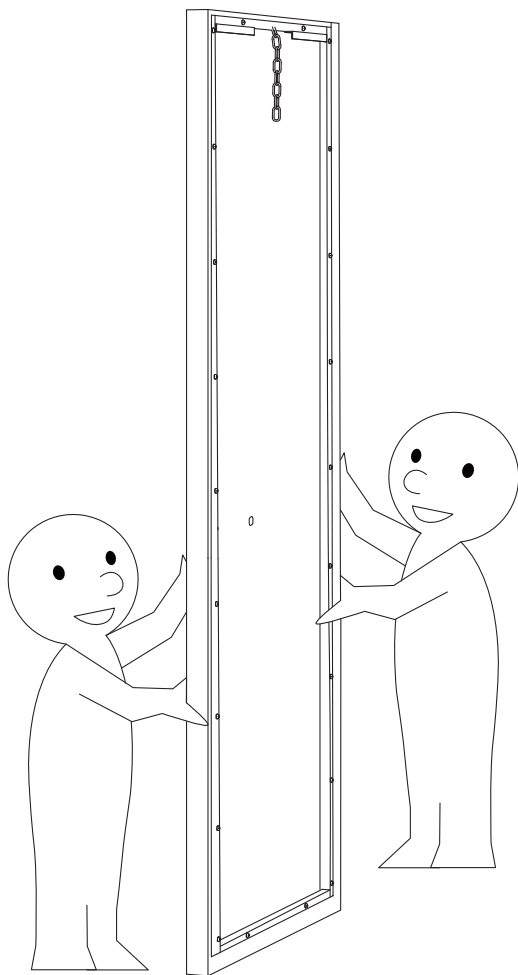

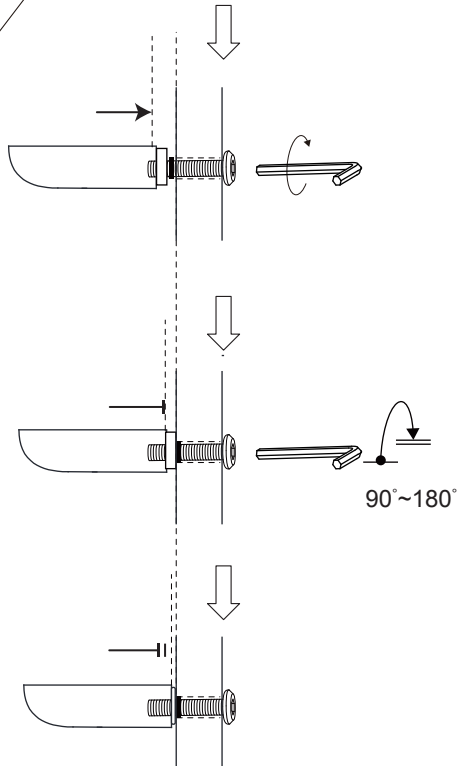
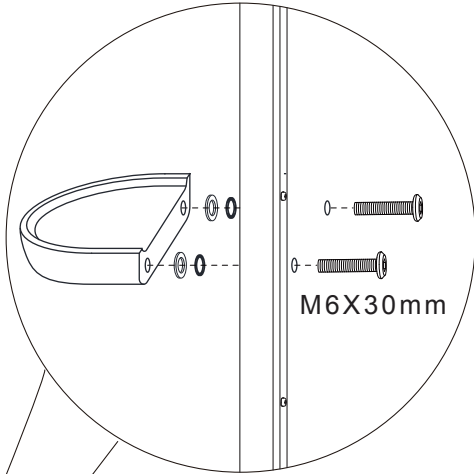
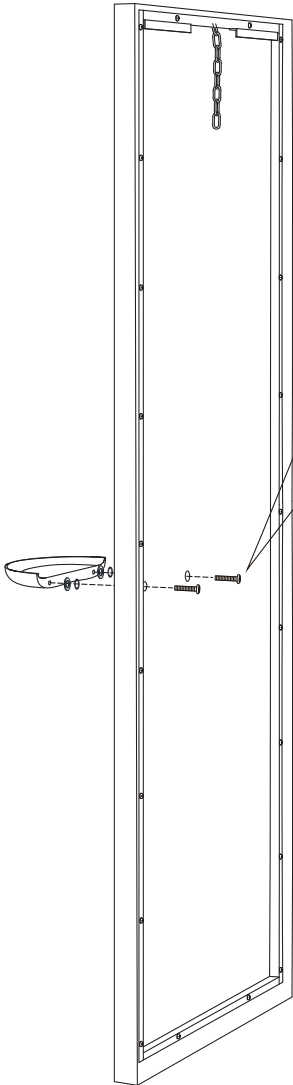
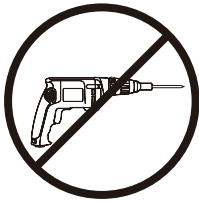

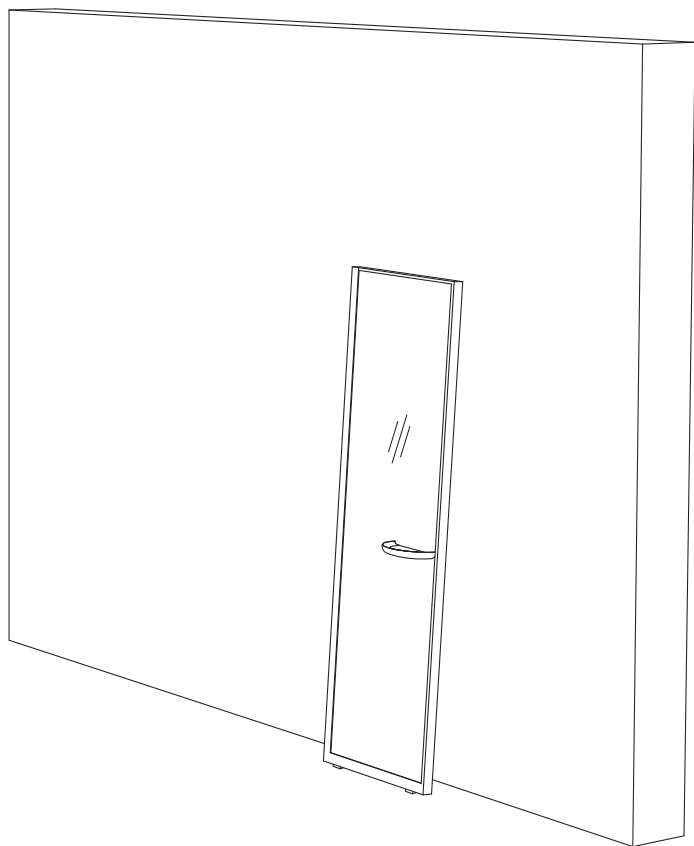

A

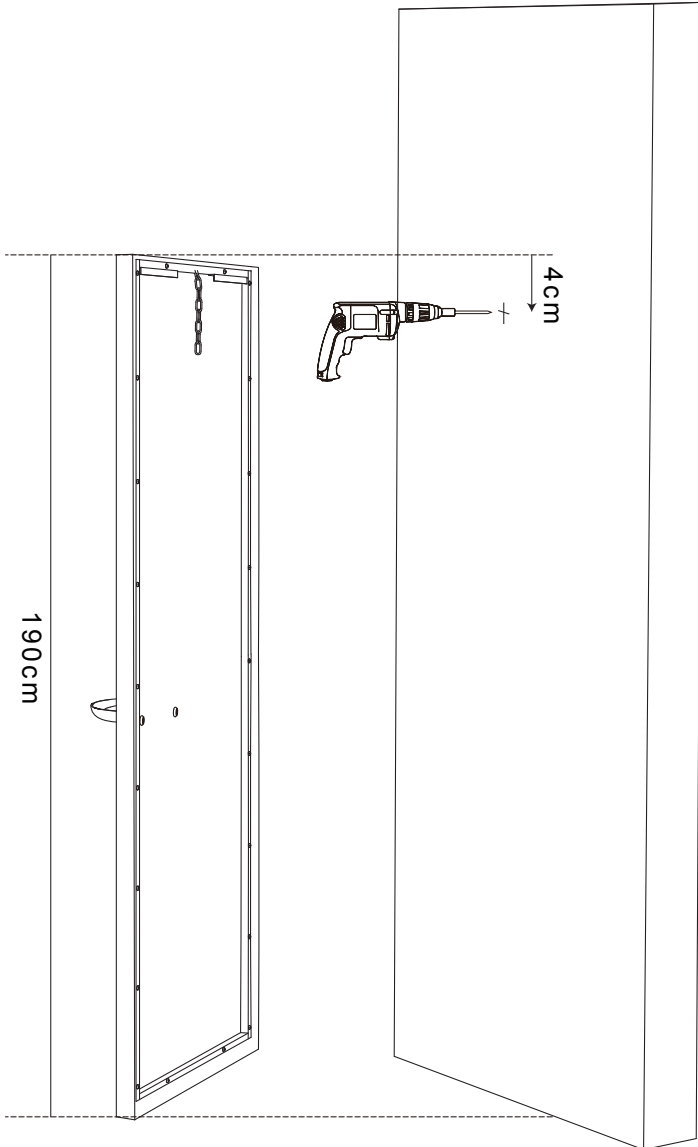

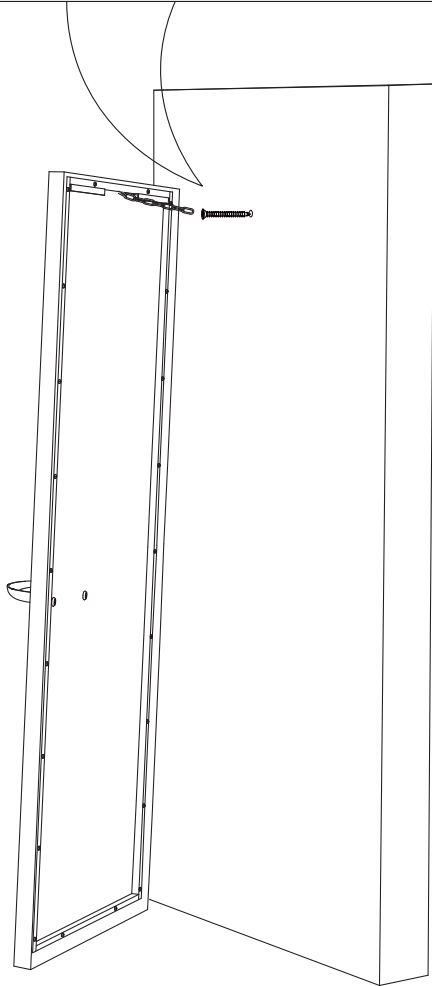
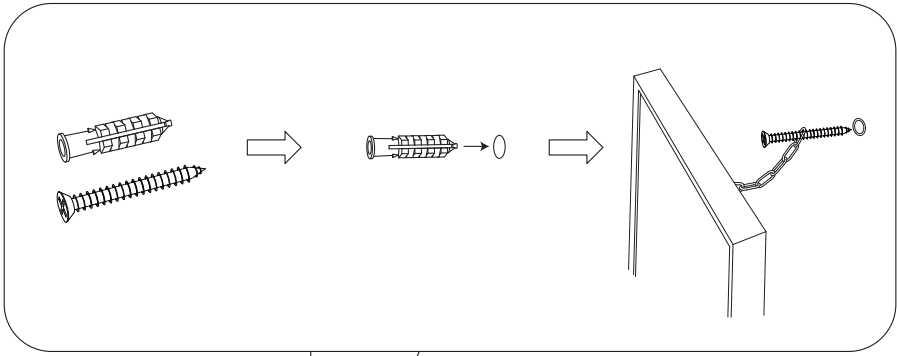

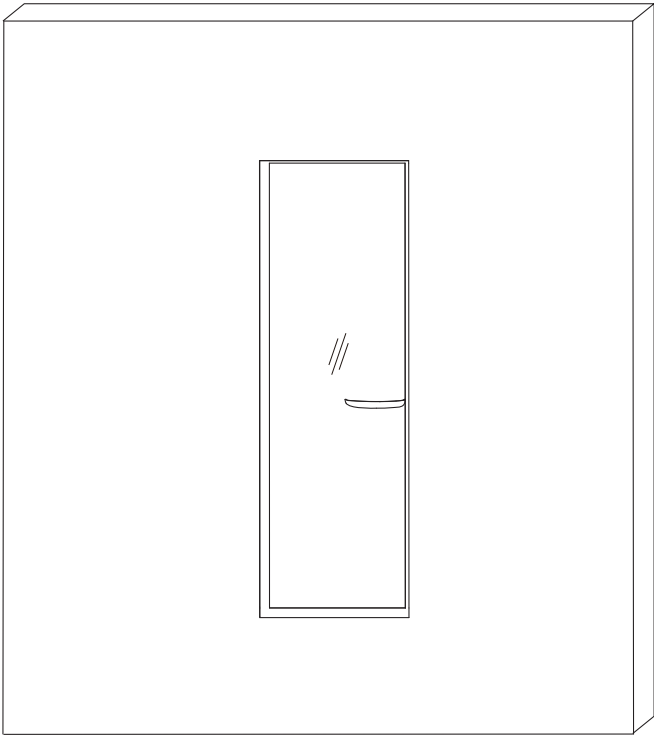

B

