

CAMERICH

北京全福凯旋家具有限公司
Beijing Triumph Furniture Co.,Ltd.

北京市通州区大杜社101103
DaDushe, TongZhou District, Beijing, China
Tel:86-10-61586106
www.camerich.com E-mail:info@camerich.com

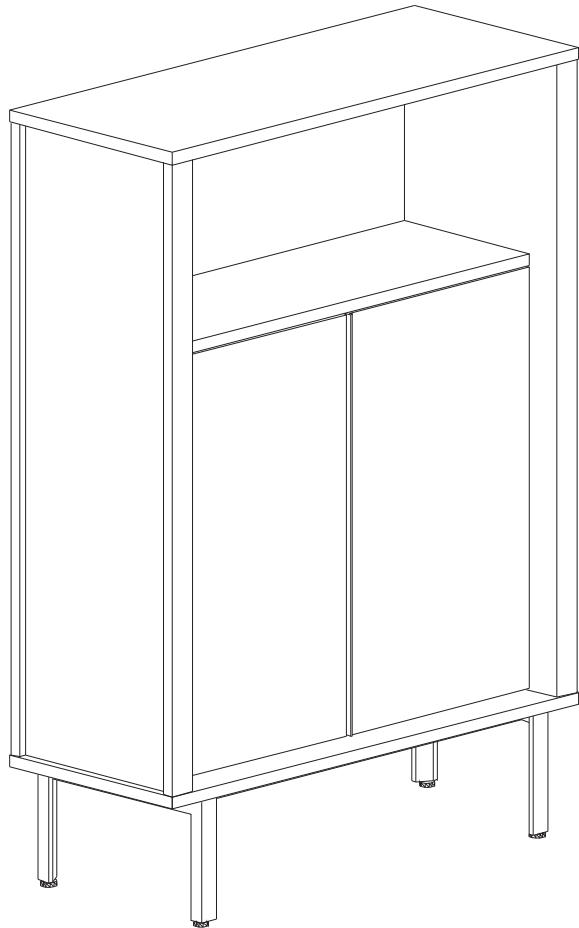

CAMERICH

安装示意图

Install Instruction





STILTS-06
C04A1906.

STILTS-06

包装清单

序号	包装部件	包装箱号
1	侧板两块、五金盒	1/4
2	顶底板两块、横隔板一块、层板两块	2/4
3	背板一块、门板两块	3/4
4	柜腿	4/4

五金盒清单









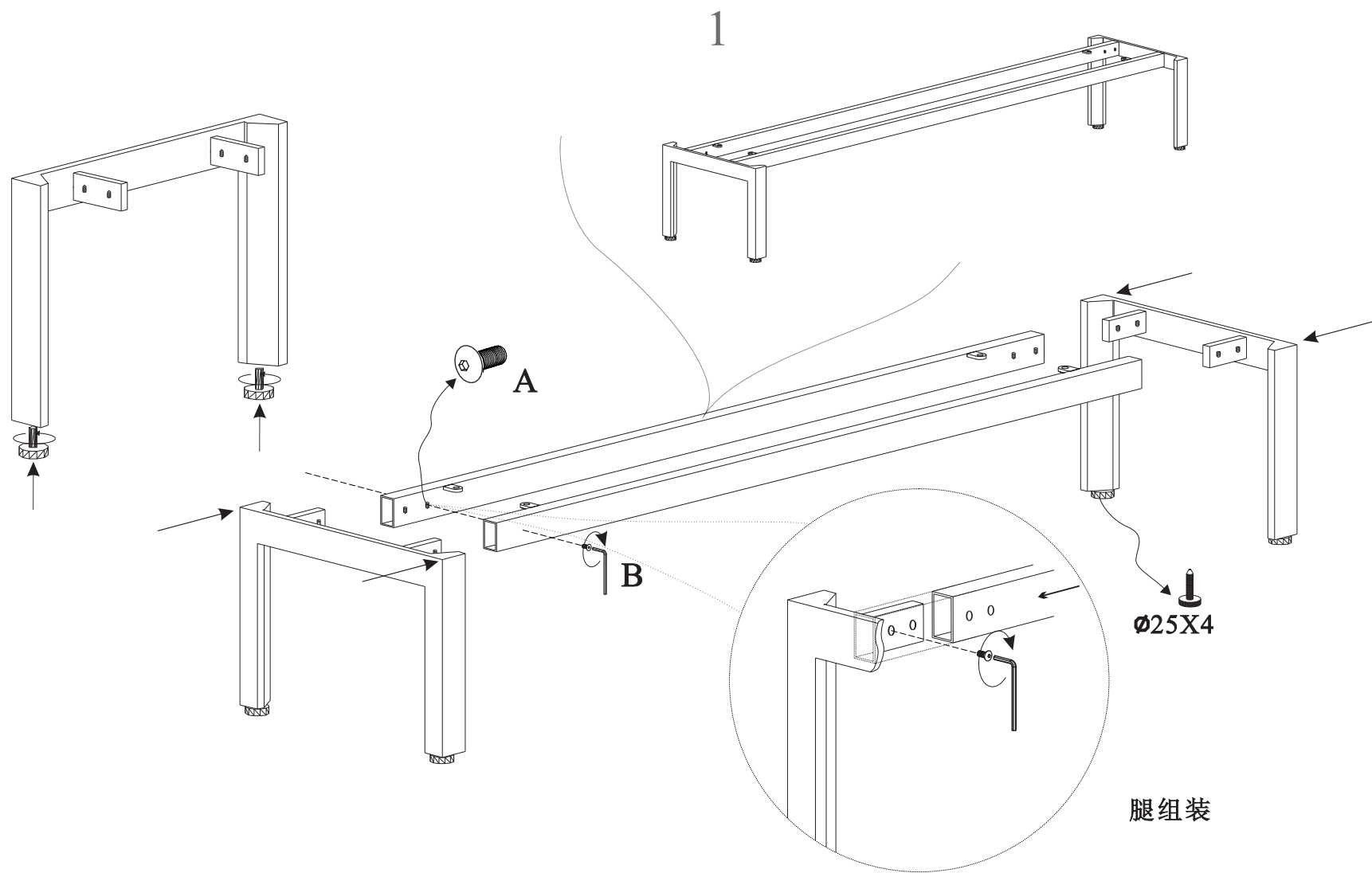

序号	样图	规格名称	数量
A		圆内黑镍, M8*16	8
B		内六角扳手, M5	1
C		三合一 (DTC) 黑色, 1552A+8234+K010	24
D		木削, M10*40, 2000/袋	8
E		自攻丝, 4*16, 锌, 1500个/盒	22
F		STILTS门档	1
G		平内黑, M6*16	4
H		阻尼铰链, 内嵌	4
I		层板肖, D5	8
J		内六角扳手, M4	1

部件清单

序号	名称	规格	单位	数量
①	顶底板	1200*402 *26	MM	2
②	侧板	1368*400 *60	MM	2
③	背板	1368*1078*18	MM	1
④	固定层板	1078*372 *26	MM	1
⑤	活动层板	1075*335 *18	MM	2
⑥	门板	912 *535 *18	MM	2

C04A1906.









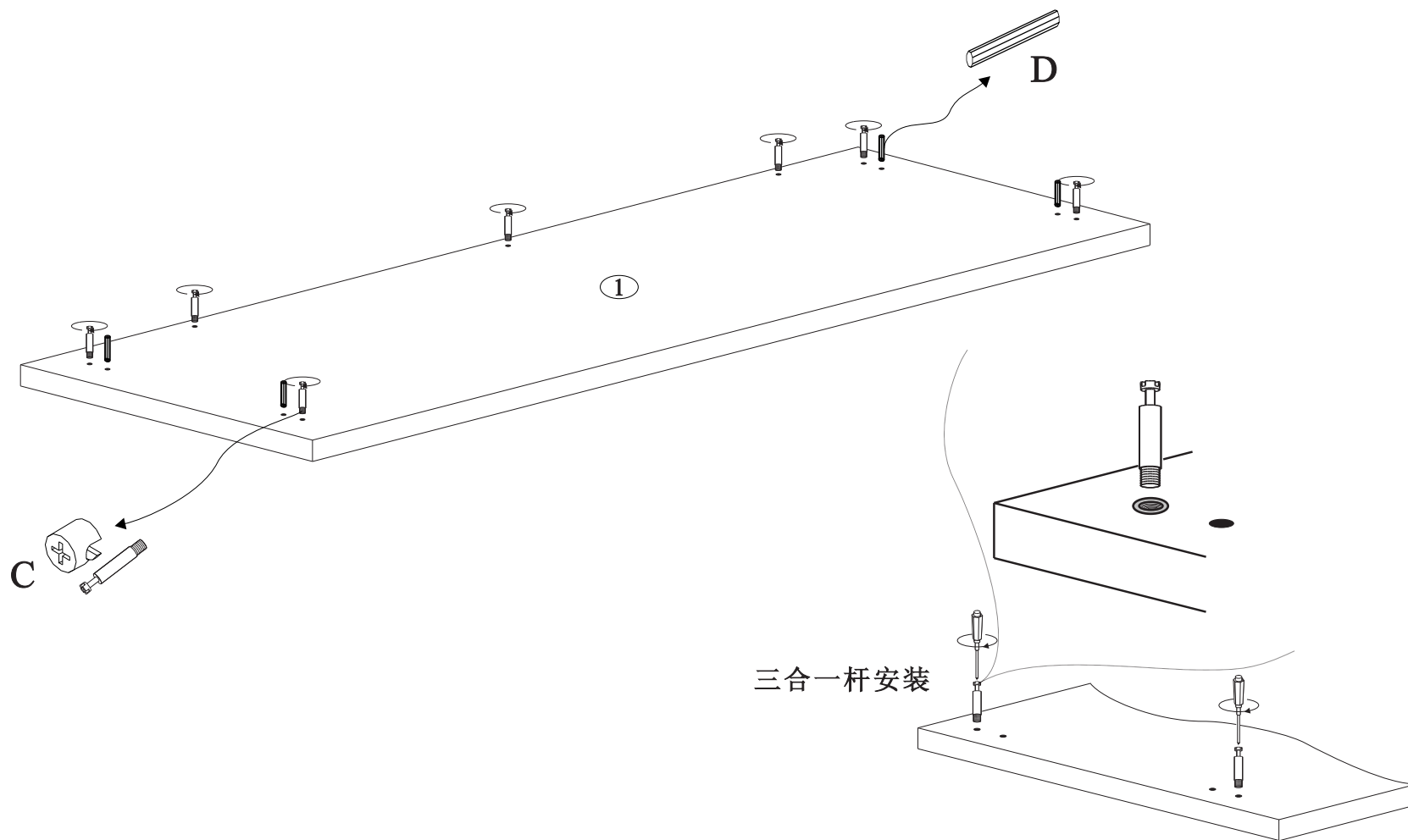



									
M8X16	M5	Ø15X15	Ø10X40	M4X16	门档	M6X16	内嵌铰链	Ø 5	M4
A	B	C	D	E	F	G	H	I	J

C04A1906.

2



三合一杆安装

									
M8X16	M4	Ø15X15	Ø10X40	M4X16	门档	M6X16	内嵌铰链	Ø 5	M4
A	B	C	D	E	F	G	H	I	J

C04A1906.

3

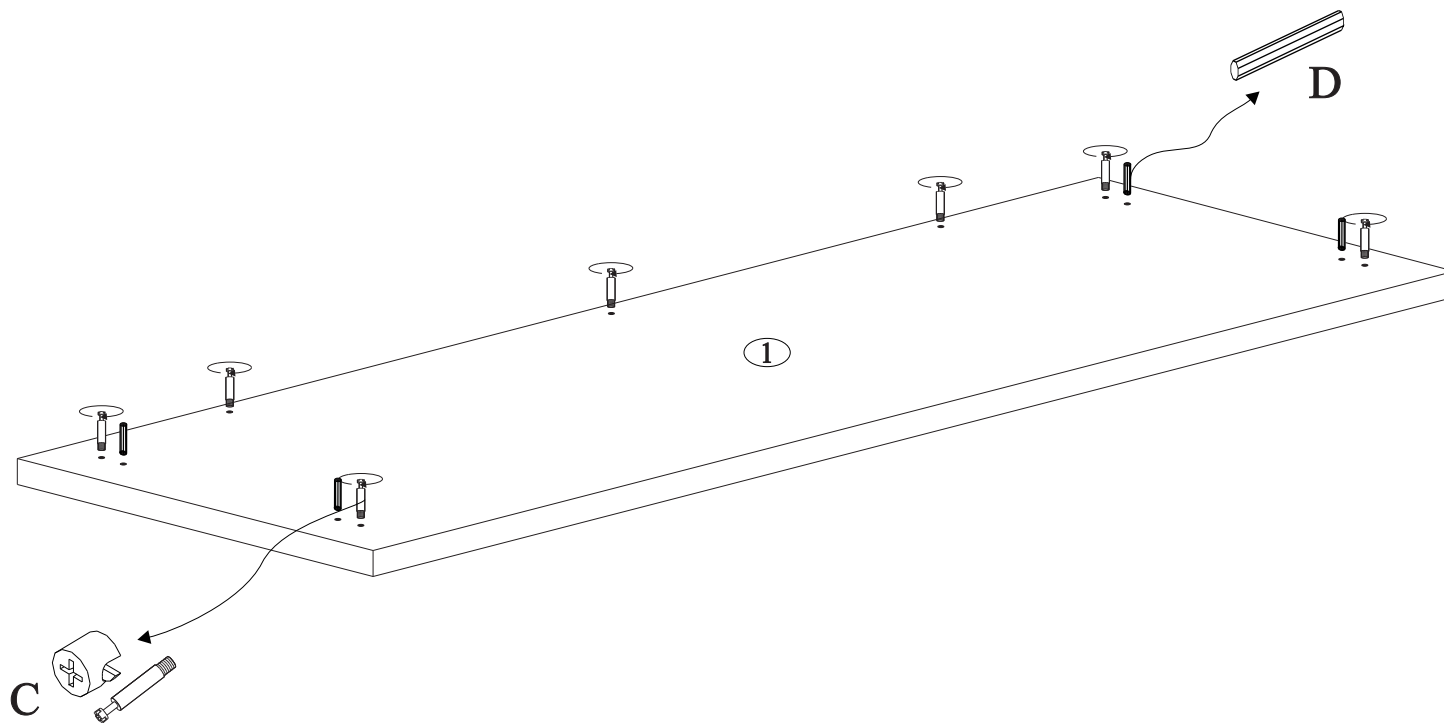







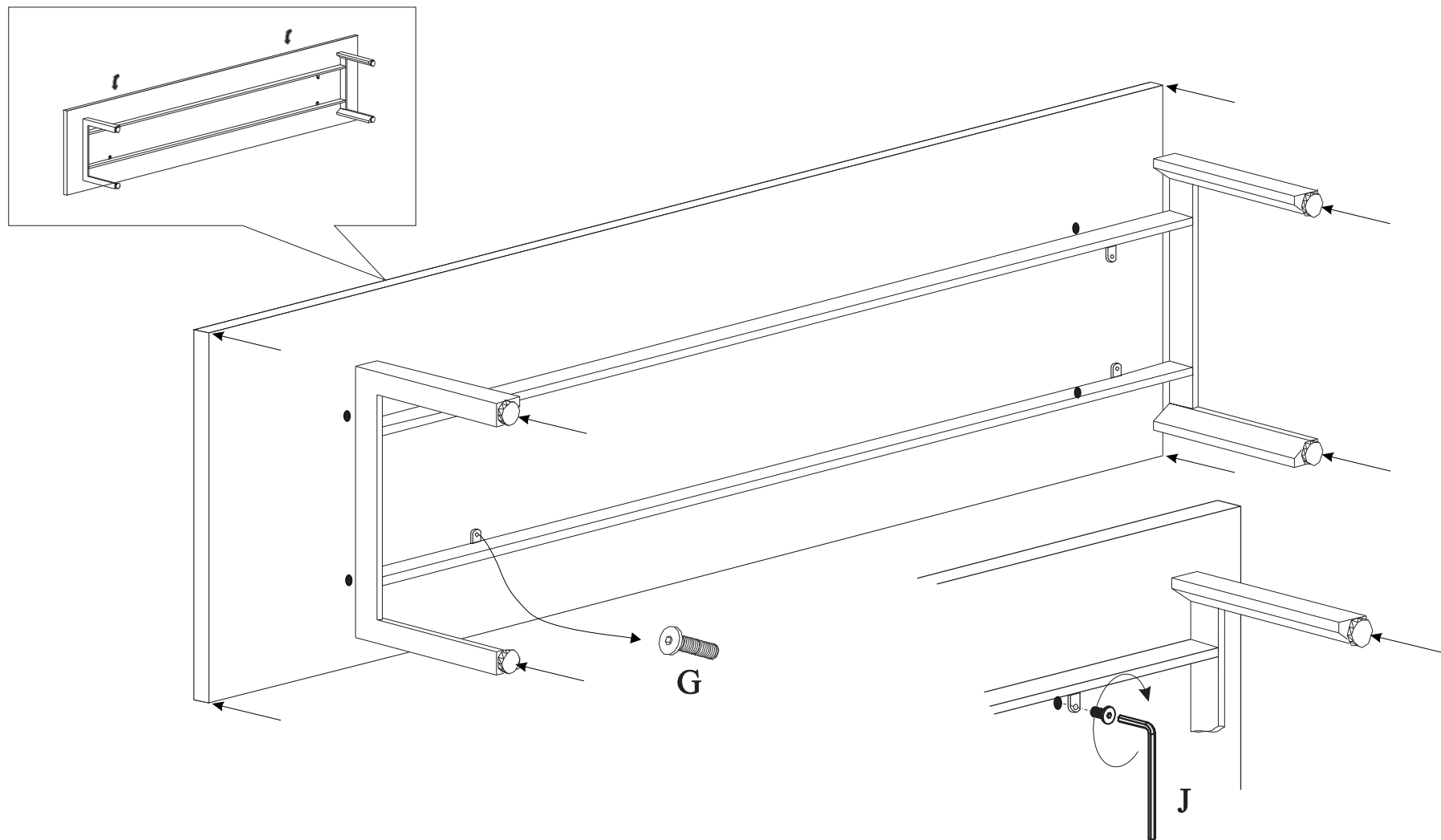

M8X16	M4	Ø15X15	Ø10X40	M4X16	门档	M6X16	内嵌铰链	Ø 5	M4
A	B	C	D	E	F	G	H	I	J

C04A1906.

4







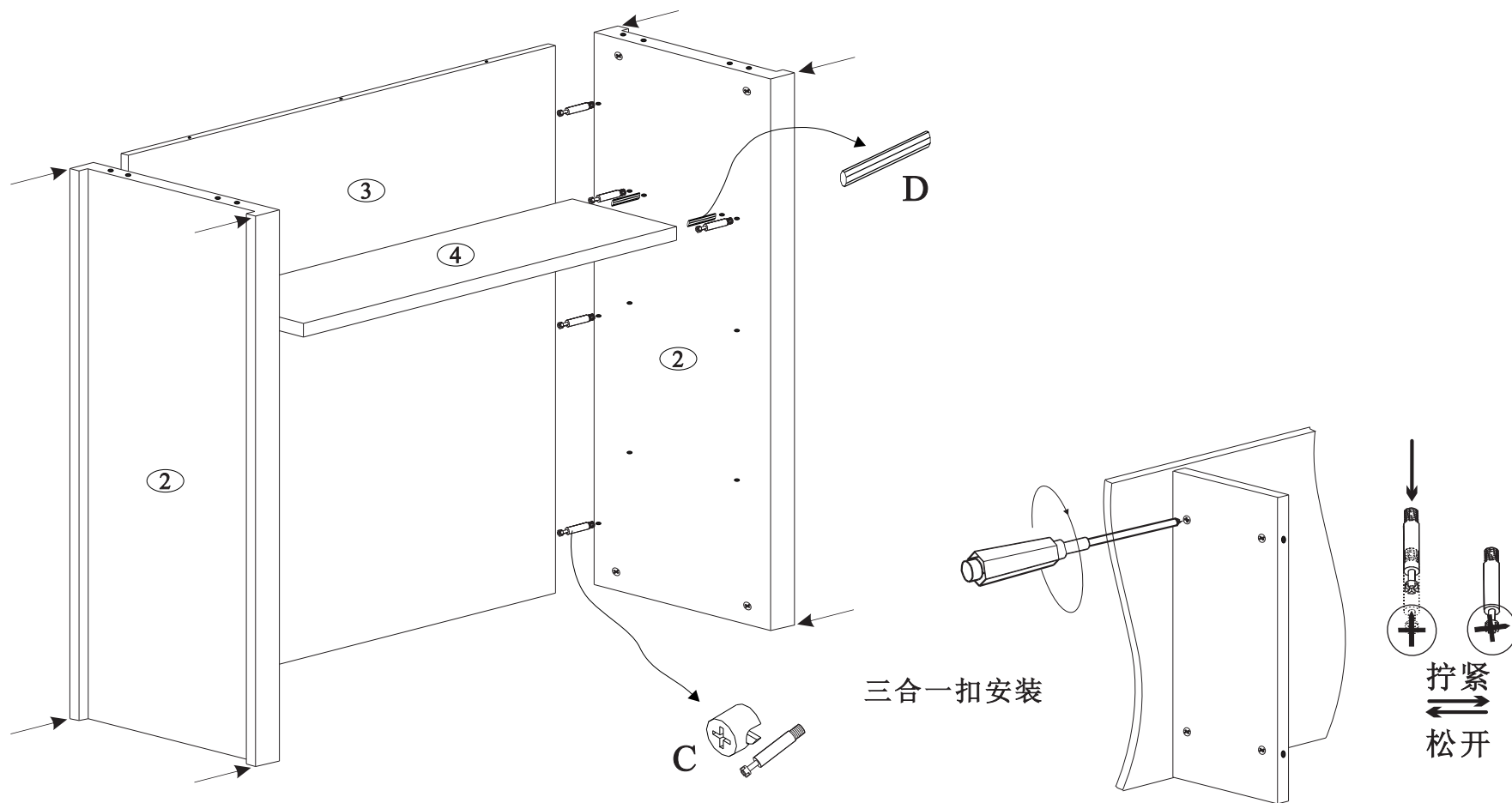

									
M8X16	M4	Ø15X15	Ø10X40	M4X16	门档	M6X16	内嵌铰链	Ø 5	M4
A	B	C	D	E	F	G	H	I	J

C04A1906.

5



									
M8X16	M4	Ø15X15	Ø10X40	M4X16	门档	M6X16	内嵌铰链	Ø 5	M4
A	B	C	D	E	F	G	H	I	J

C04A1906.

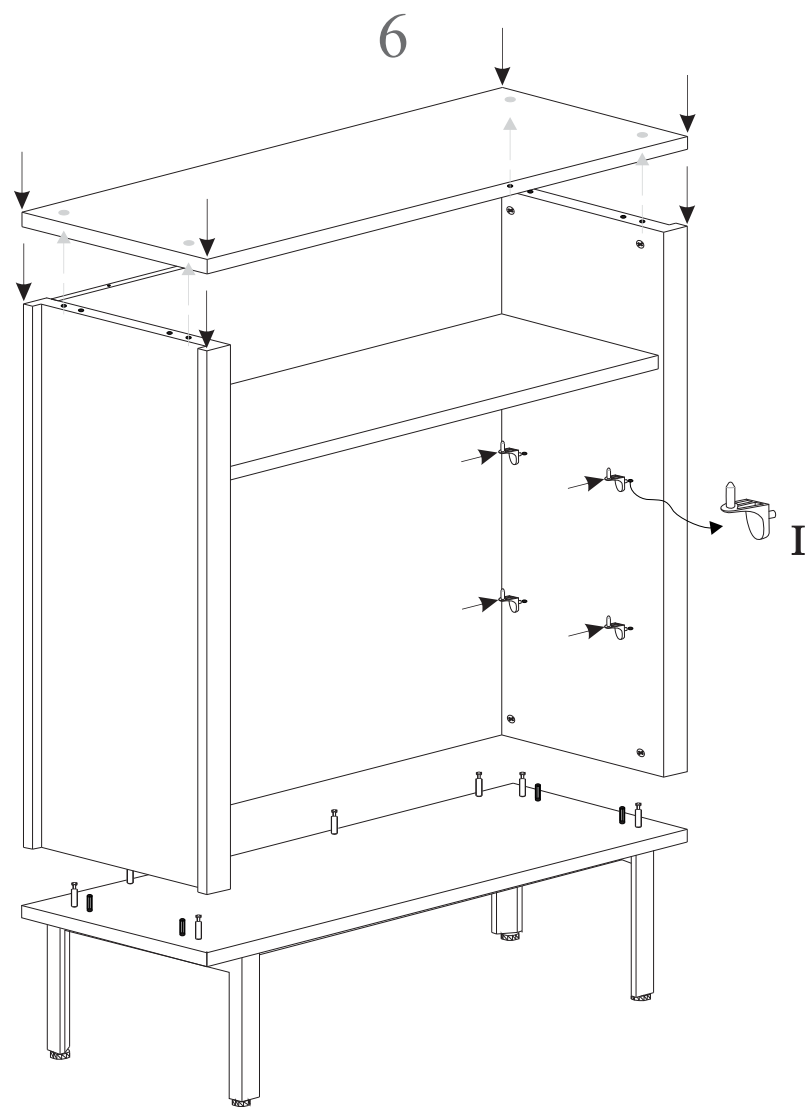

M8X16 M4 Ø15X15 Ø10X40 M4X16 门档 M6X16 内嵌铰链 Ø 5 M4

A B C D E F G H I J

C04A1906.

7

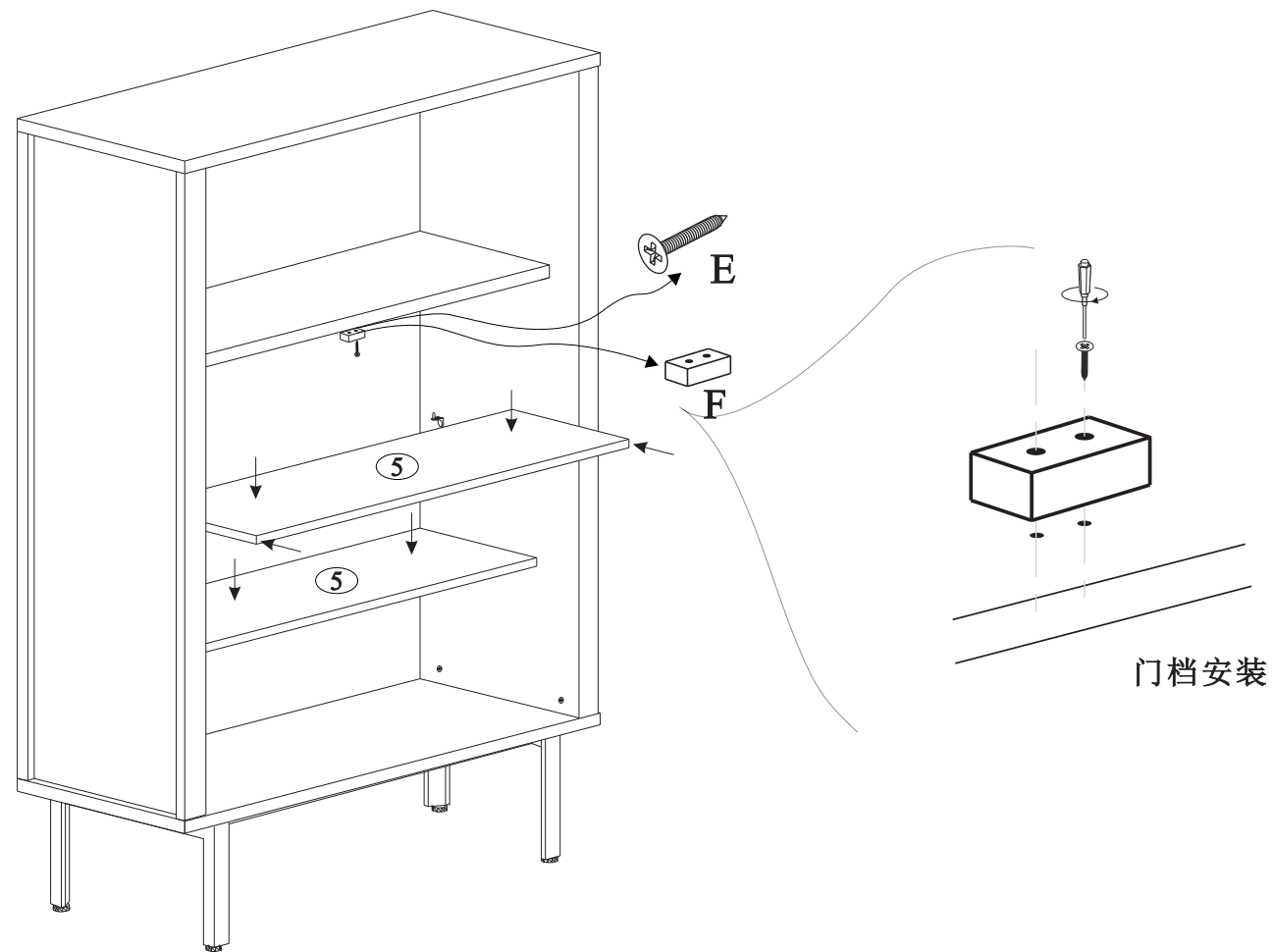

门档安装











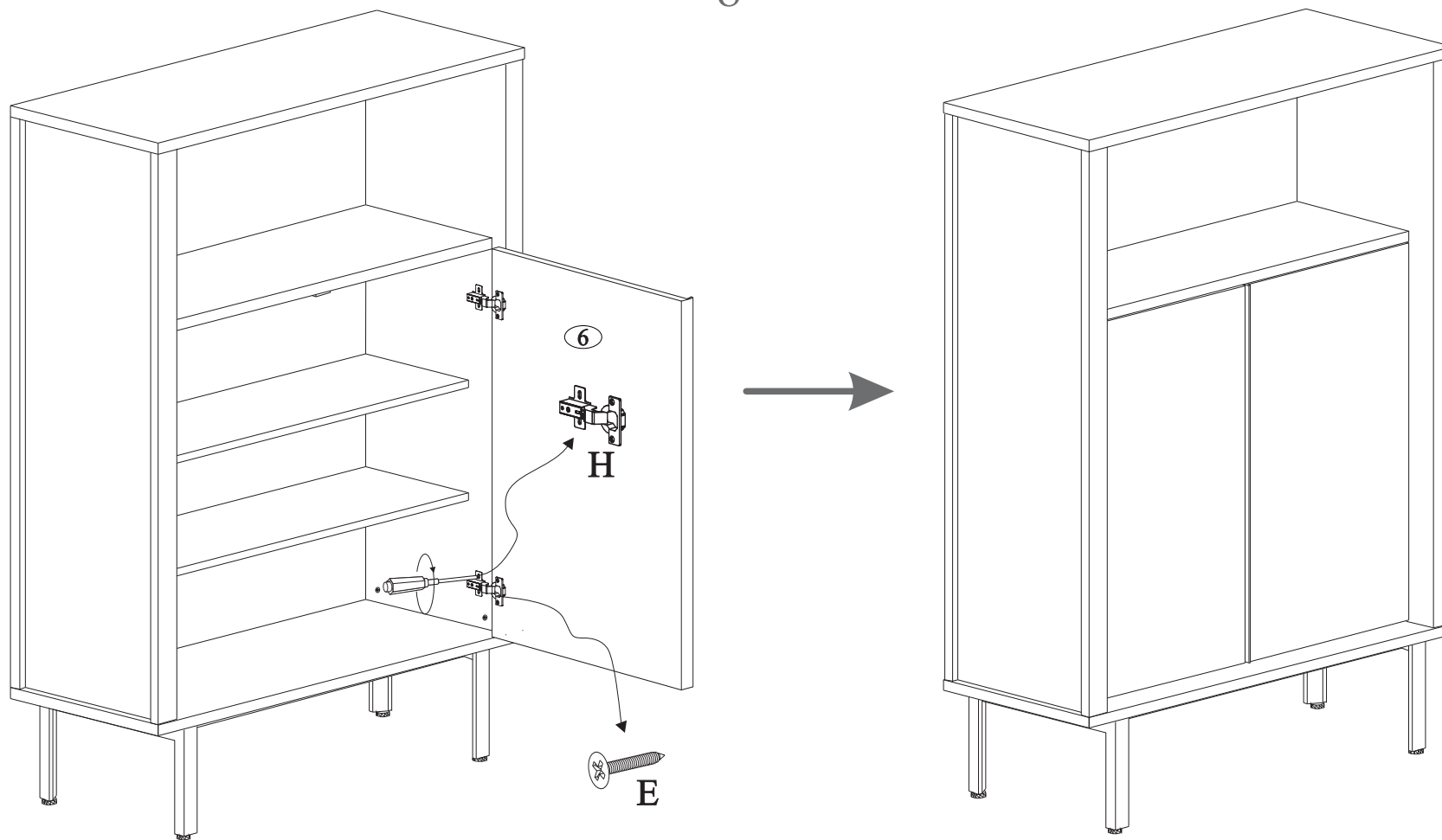

M8X16 M4 Ø15X15 Ø10X40 M4X16 门档 M6X16 内嵌铰链 Ø 5 M4

A B C D E F G H I J

C04A1906.

8



									
M8X16	M4	Ø15X15	Ø10X40	M4X16	门档	M6X16	内嵌铰链	Ø 5	M4
A	B	C	D	E	F	G	H	I	J