

CAMERICH

北京全福凯旋家具有限公司
Beijing Triumph Furniture Co.,Ltd.

北京市通州区大杜社101103
DaDushe, TongZhou District, Beijing, China
Tel:86-10-61586106
www.camerich.com E-mail:info@camerich.com

CAMERICH

安装示意图

Install Instruction

STILTS-05
C04A1905.

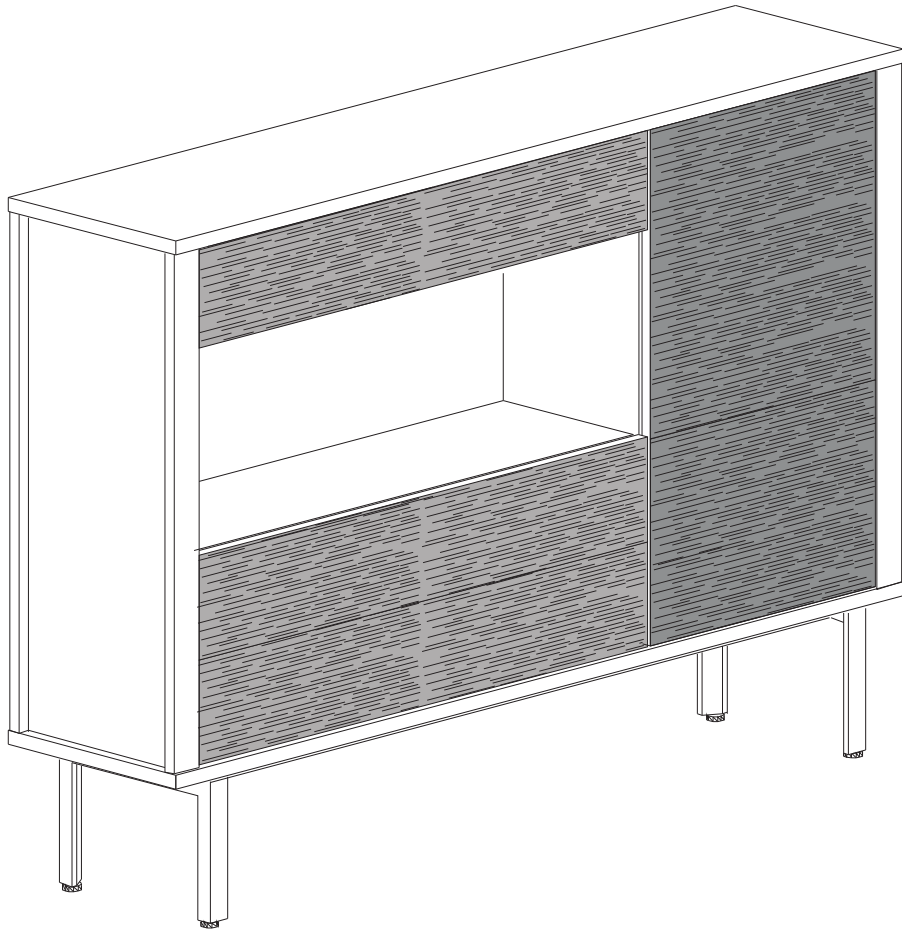















STILTS-05

包装清单

序号	包装部件	包装箱号
1	柜腿、五金盒	1/4
2	背板、门板、屉面、翻门各一块、抽屉一套	2/4
3	侧板两块、中山一块、屉面三块	3/5
4	顶底板两块、个顶层板两块	4/5

五金盒清单









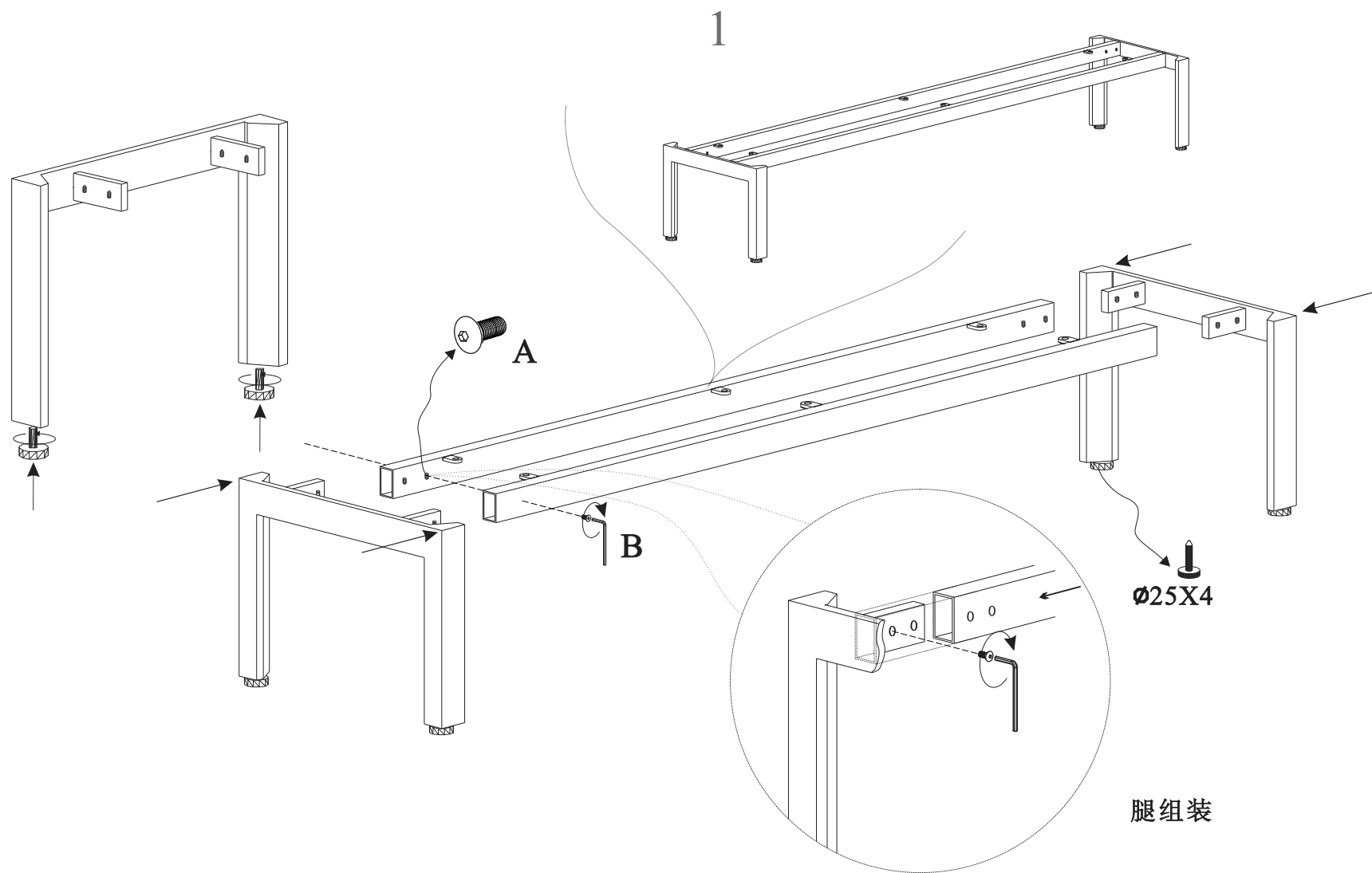





序号	样图	规格名称	数量
A		圆内黑镍, M8*16	8
B		内六角扳手, M5	1
C		三合一 (DTC) 黑色, 1552A+8234+K010	34
D		木削, M10*40, 2000/袋	8
E		自攻丝, 4*16, 锌, 2000个/盒	36
F		STILTS门吸	1
G		平内黑, M6*16	6
H		阻尼铰链内嵌	4
I		下翻门拉杆	2
J		层板肖, D5	12
K		Quadro 25, 推入式, 隐藏式滑轨, 部分拉出带阻尼, 300mm, EB20,	1
L		大扁头, 4*25, 黑, 600个/盒	4
M		二合一连接件, 锁扣9*12	20
N		木肖, M6*30, 2000/袋	4
O		内六角扳手, M4	4

部件清单

序号	名称	规格	单位	数量
①	顶底板	1378*402 *26	MM	2
②	侧板	918 *400 *60	MM	2
③	背板	1616*918 *18	MM	1
④	中山	918 *346 *18	MM	1
⑤	固定层板	1078*346 *18	MM	2
⑥	活动层板	517 *330 *18	MM	3
⑦	门板	535 *912 *19	MM	1
⑧	下翻门	1074*363 *19	MM	1
⑨	屉面	1074*205 *19	MM	1
⑩	屉堵	1038*109 *12	MM	2
⑪	屉邦	300 *120 *12	MM	2
⑫	屉底	1038*275 *12	MM	1
⑬	屉内分隔长板	1038*70 *12	MM	1
⑭	屉内分隔短板	275 *70 *12	MM	3

C04A1905.



														
M8X16	M5	Ø15X15	Ø10X40	M4X16	门吸	M6X16	内嵌铰链	下翻气撑	Ø 5	M350	M4X25	Ø12X15	Ø6X30	M4
A	B	C	D	E	F	G	H	I	J	K	L	M	N	O

C04A1905.

2

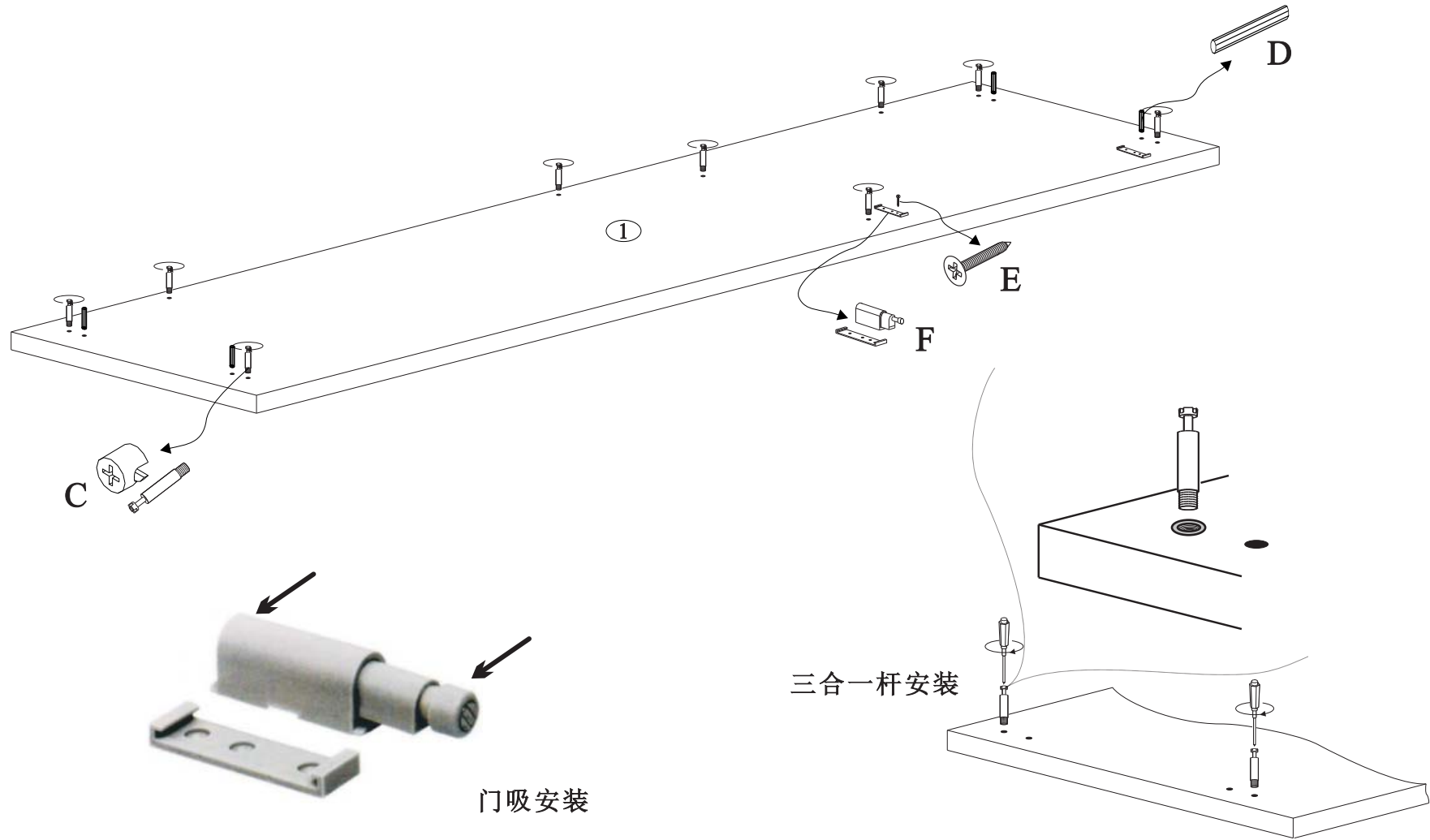

门吸安装

三合一杆安装

M8X16	M5	Ø15X15	Ø10X40	M4X16	门吸	M6X16	内嵌铰链	下翻气撑	Ø 5	M350	M4X25	Ø12X15	Ø6X30	M4
A	B	C	D	E	F	G	H	I	J	K	L	M	N	O

C04A1905.

3

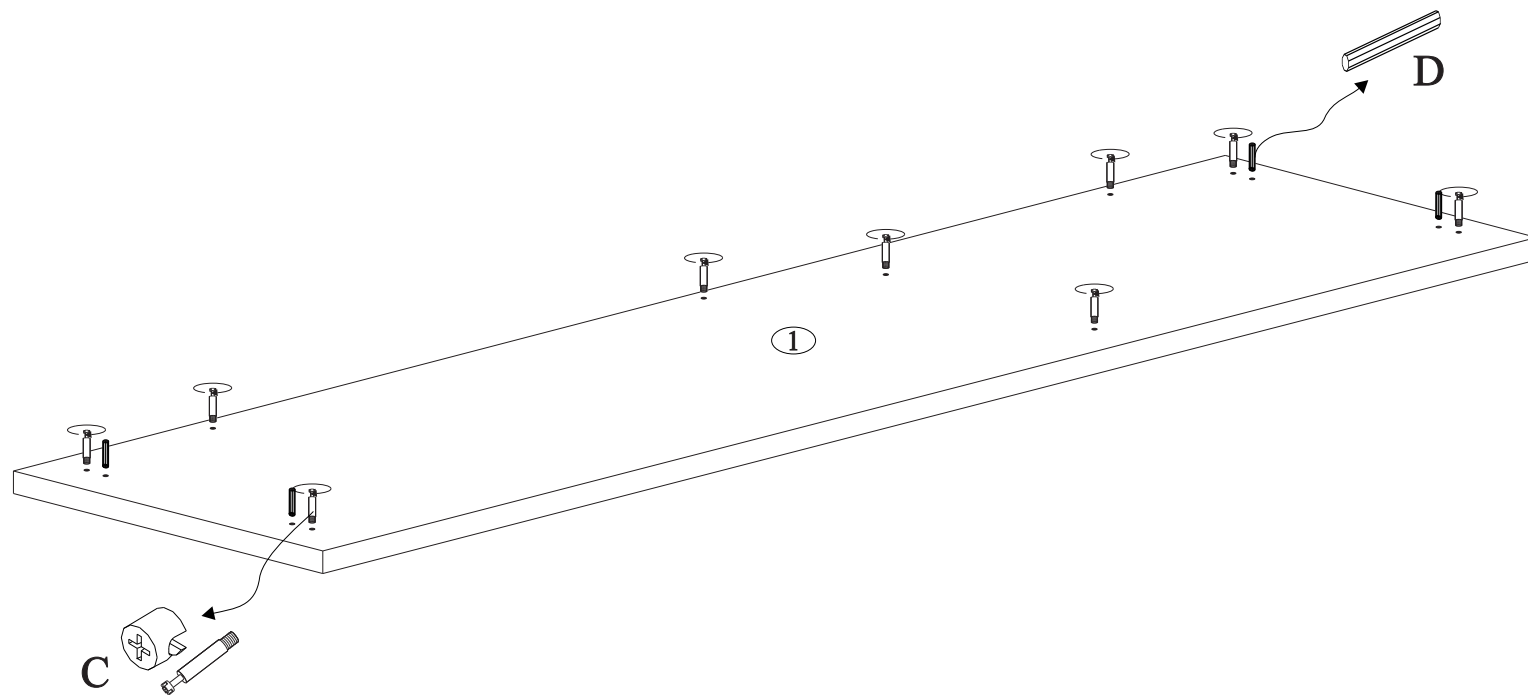







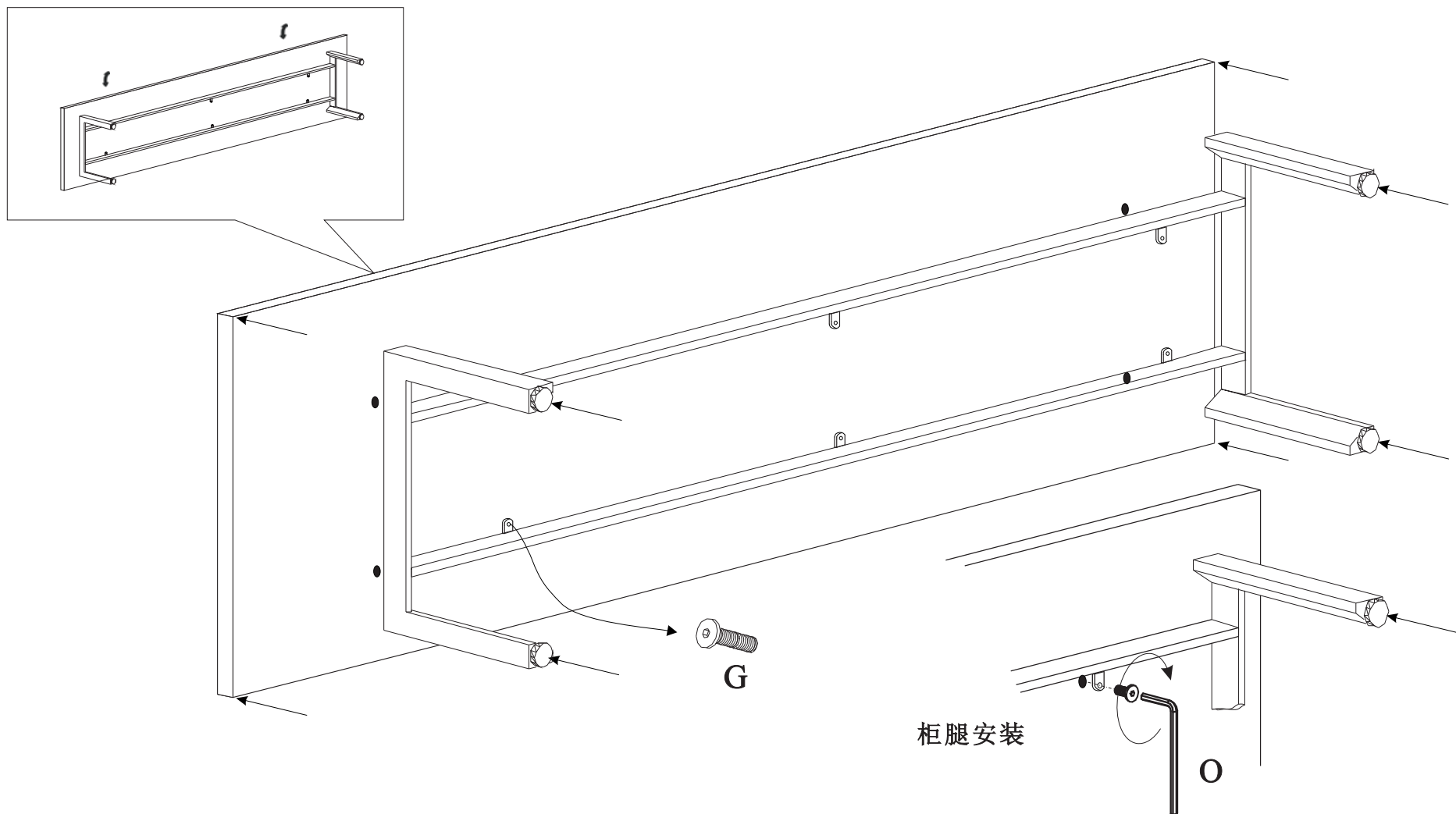







M8X16	M5	Ø15X15	Ø10X40	M4X16	门吸	M6X16	内嵌铰链	下翻气撑	Ø 5	M350	M4X25	Ø12X15	Ø6X30	M4	
A	B	C	D	E	F	G	H	I	J	K	L	M	N	O	

C04A1905.

4

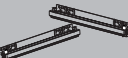







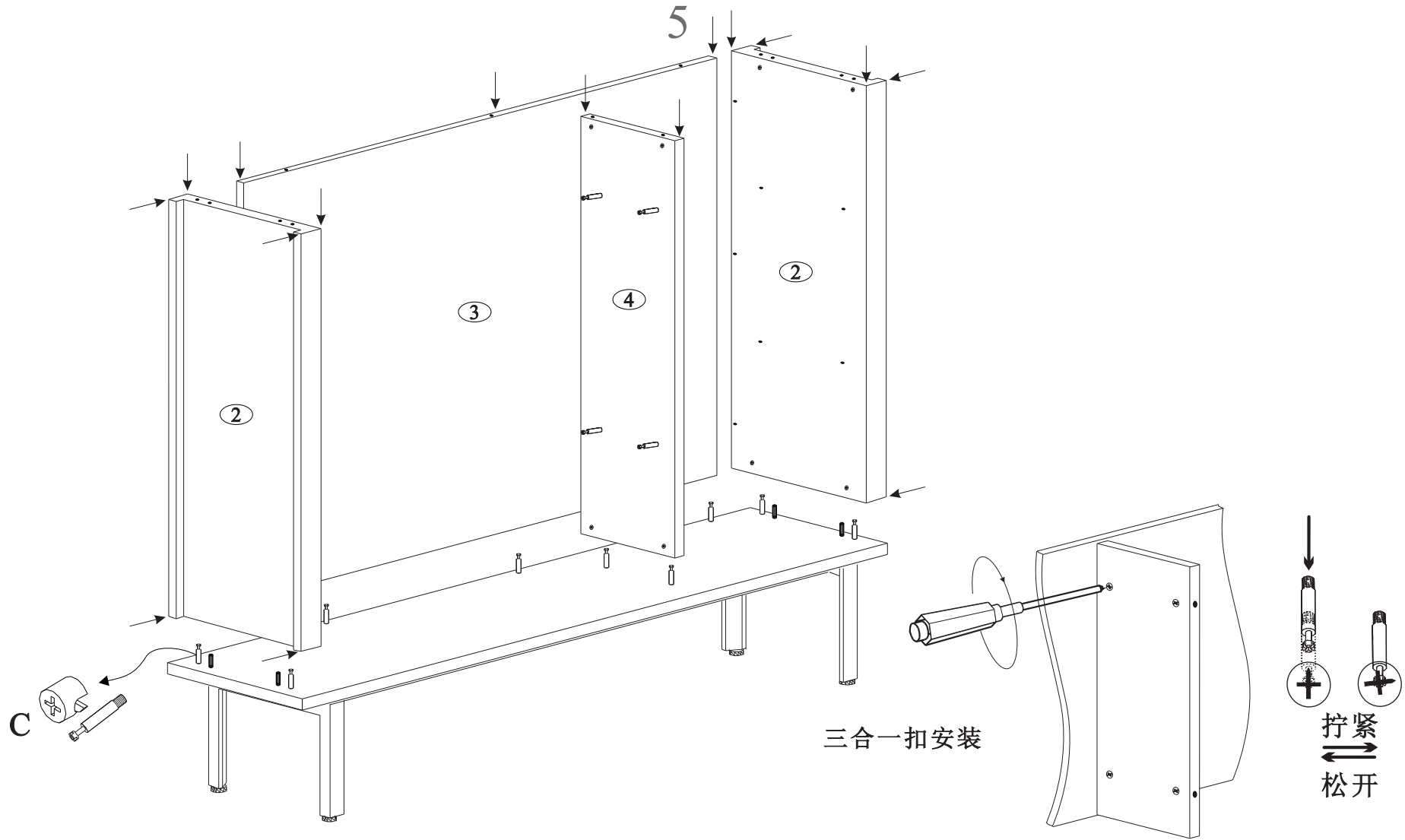







柜腿安装

														
M8X16	M5	∅15X15	∅10X40	M4X16	门吸	M6X16	内嵌铰链	下翻气撑	∅ 5	M350	M4X25	∅12X15	∅6X30	M4
A	B	C	D	E	F	G	H	I	J	K	L	M	N	O

C04A1905.



														
M8X16	M5	Ø15X15	Ø10X40	M4X16	门吸	M6X16	内嵌铰链	下翻气撑	Ø 5	M350	M4X25	Ø12X15	Ø6X30	M4
A	B	C	D	E	F	G	H	I	J	K	L	M	N	O

C04A1905.

6

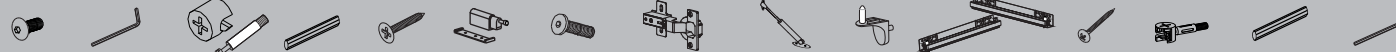
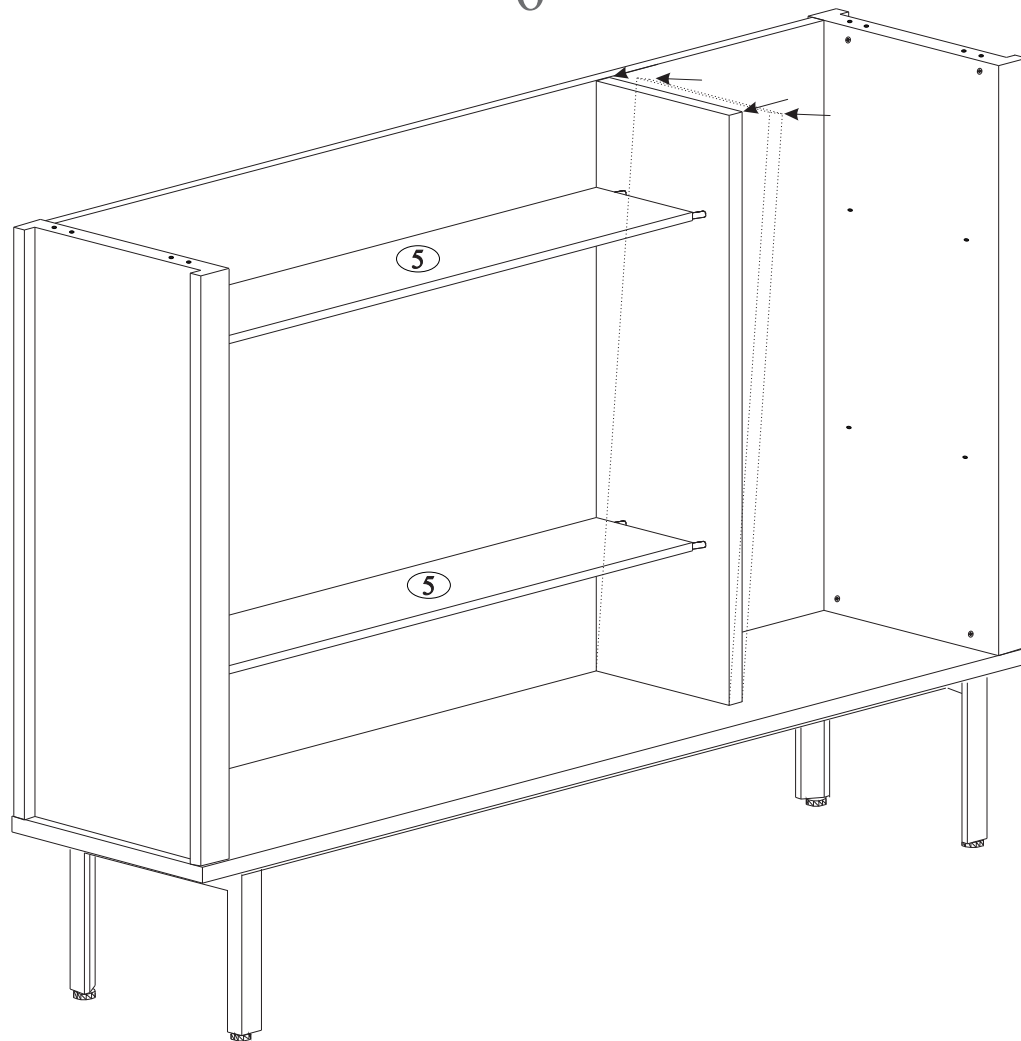







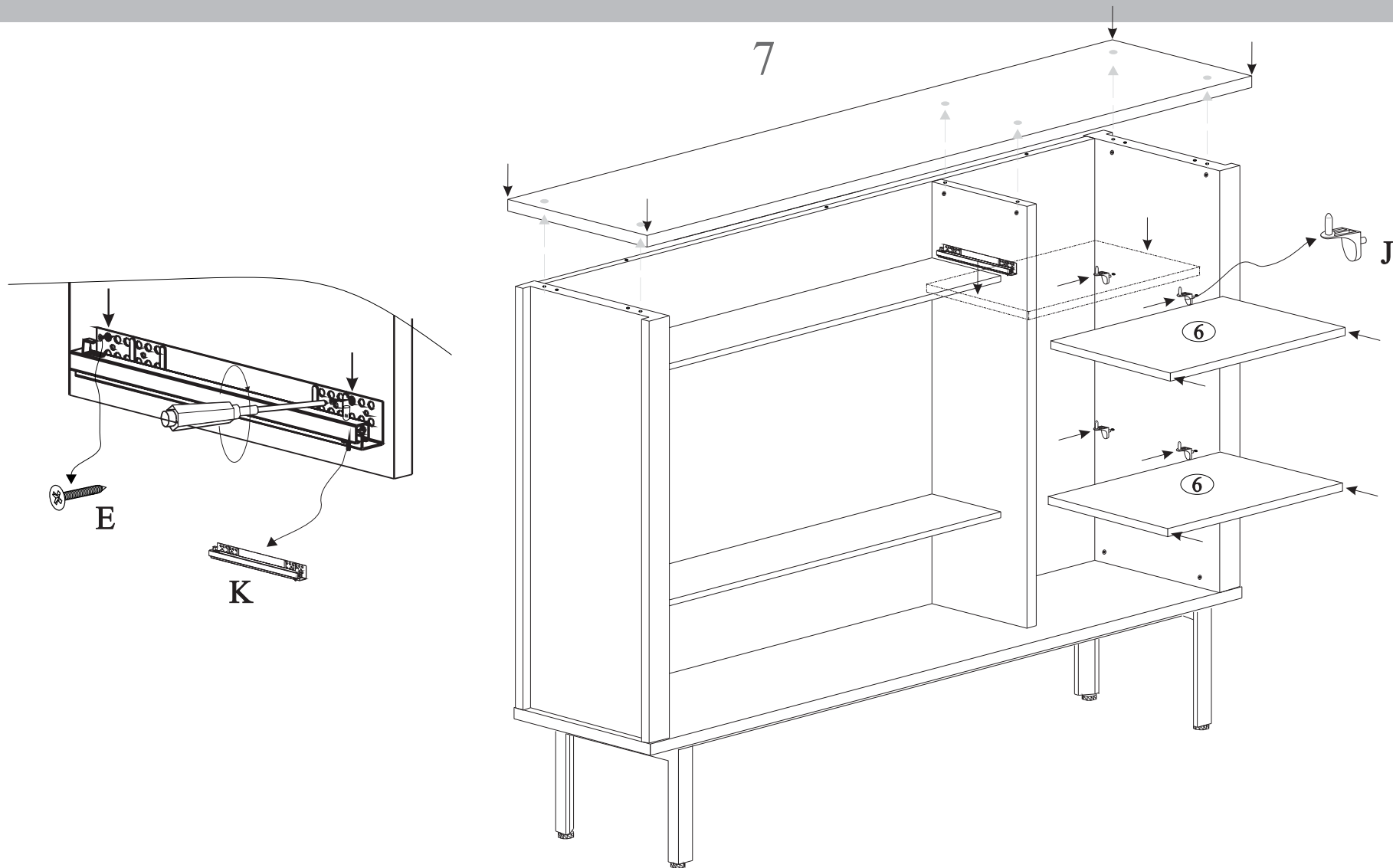







M8X16 M5 Ø15X15 Ø10X40 M4X16 门吸 M6X16 内嵌铰链 下翻气撑 Ø 5 M350 M4X25 Ø12X15 Ø6X30 M4

A B C D E F G H I J K L M N O

C04A1905.









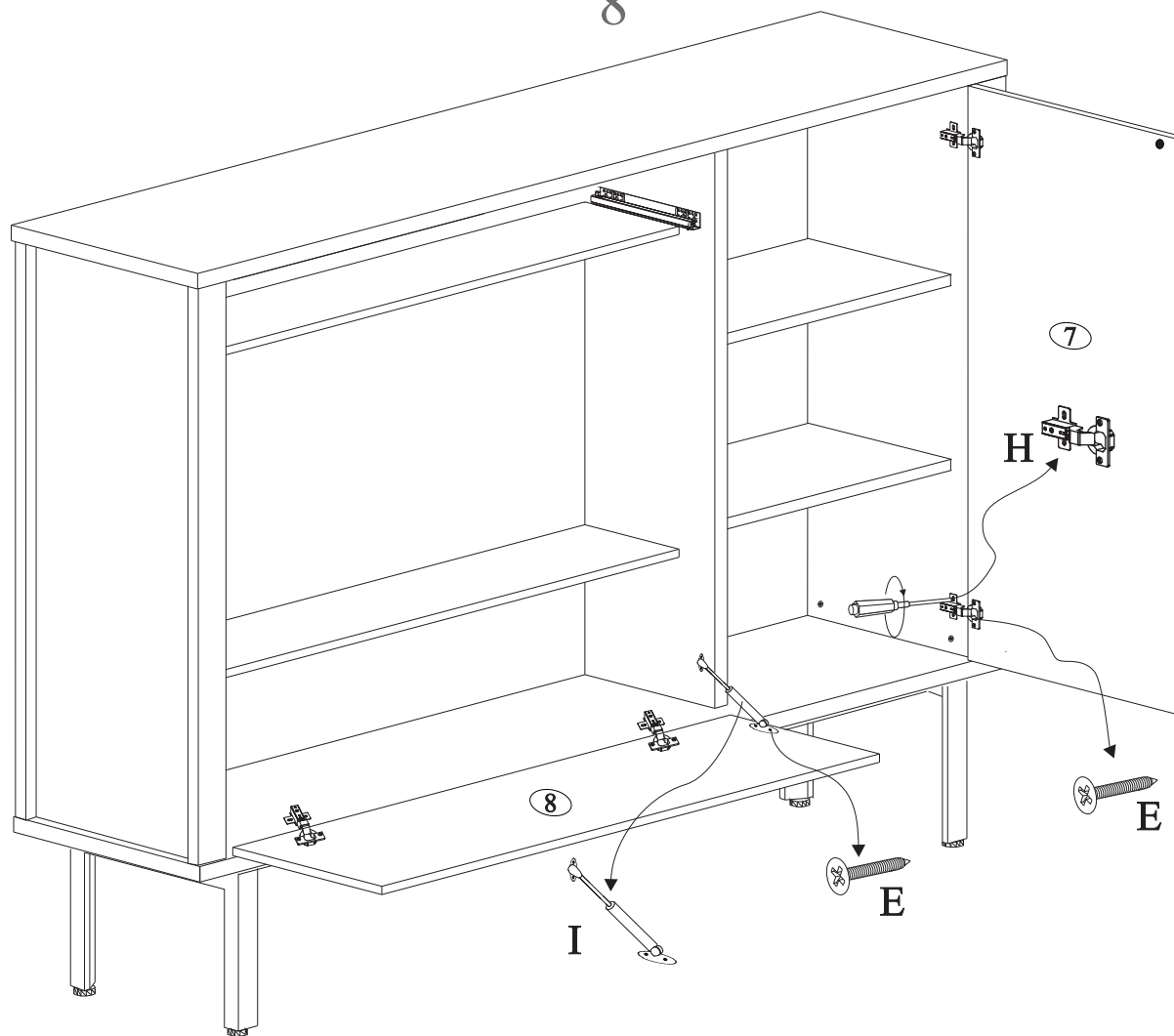







														
M8X16	M5	∅15X15	∅10X40	M4X16	门吸	M6X16	内嵌铰链	下翻气撑	∅ 5	M350	M4X25	∅12X15	∅6X30	M4
A	B	C	D	E	F	G	H	I	J	K	L	M	N	O

C04A1905.

8



														
M8X16	M5	Ø15X15	Ø10X40	M4X16	门吸	M6X16	内嵌铰链	下翻气撑	Ø 5	M350	M4X25	Ø12X15	Ø6X30	M4
A	B	C	D	E	F	G	H	I	J	K	L	M	N	O

C04A1905.

9

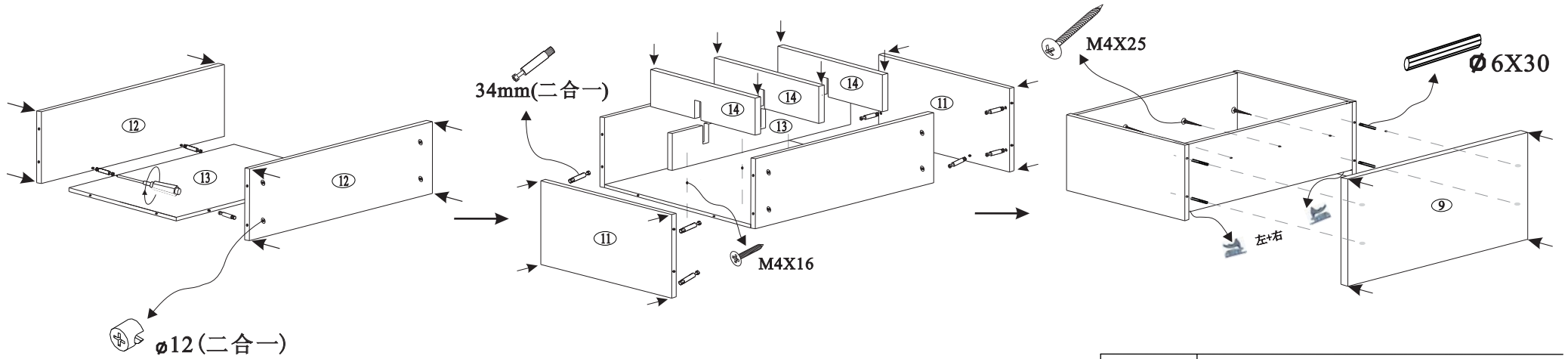

I



II



III

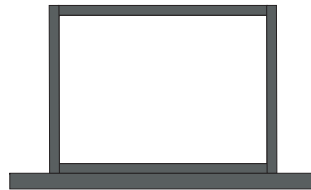

IV

适用产品	C04A1905.					
代码	I	II	III	IV	V	VI
图标						
规格	34mm	Ø12(二合一)	Ø6X30	M4X25	M4X16	左+右
数量	20	20	4	4	20	2

C04A1905.

10

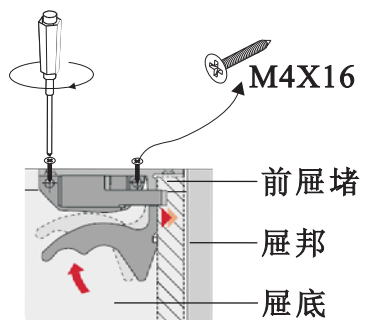
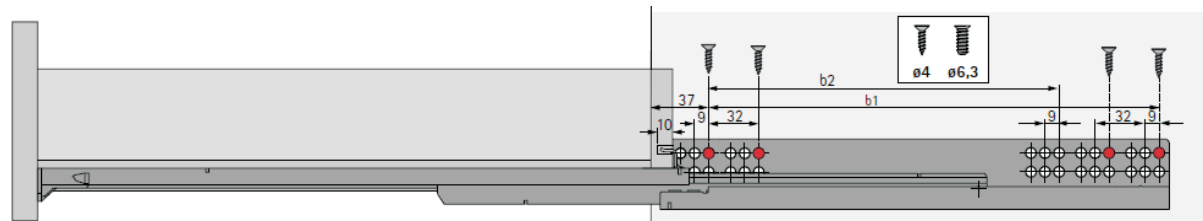
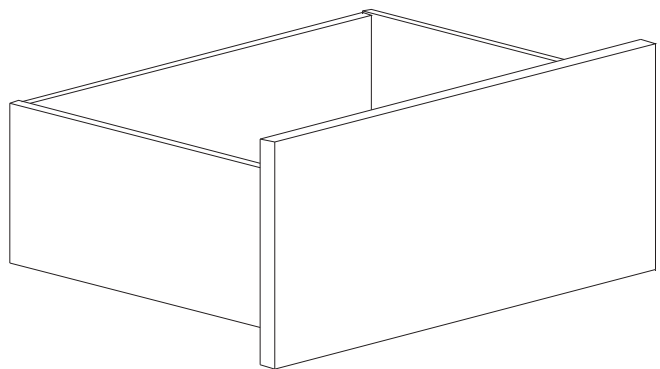

M4X16

前屉堵

屉邦

屉底

快装扣手安装

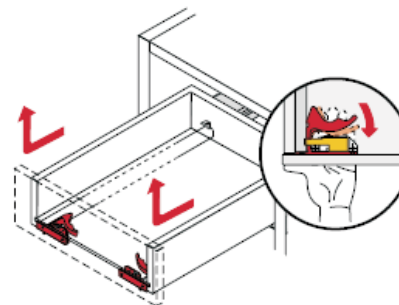
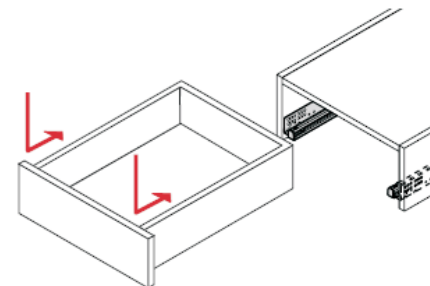
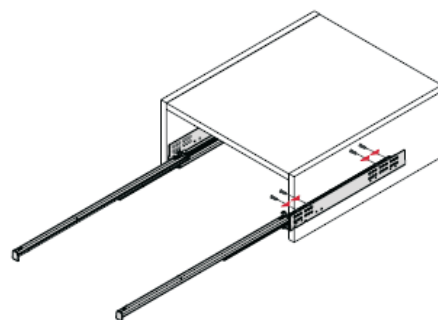
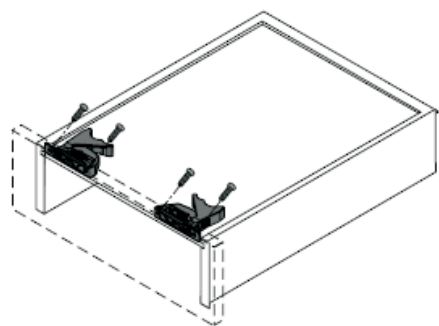

抽屉拆装

C04A1905.

11

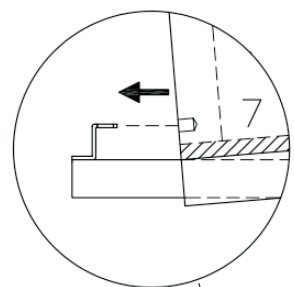

First

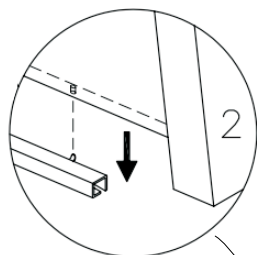

Second

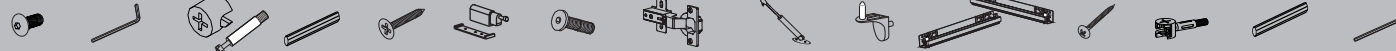
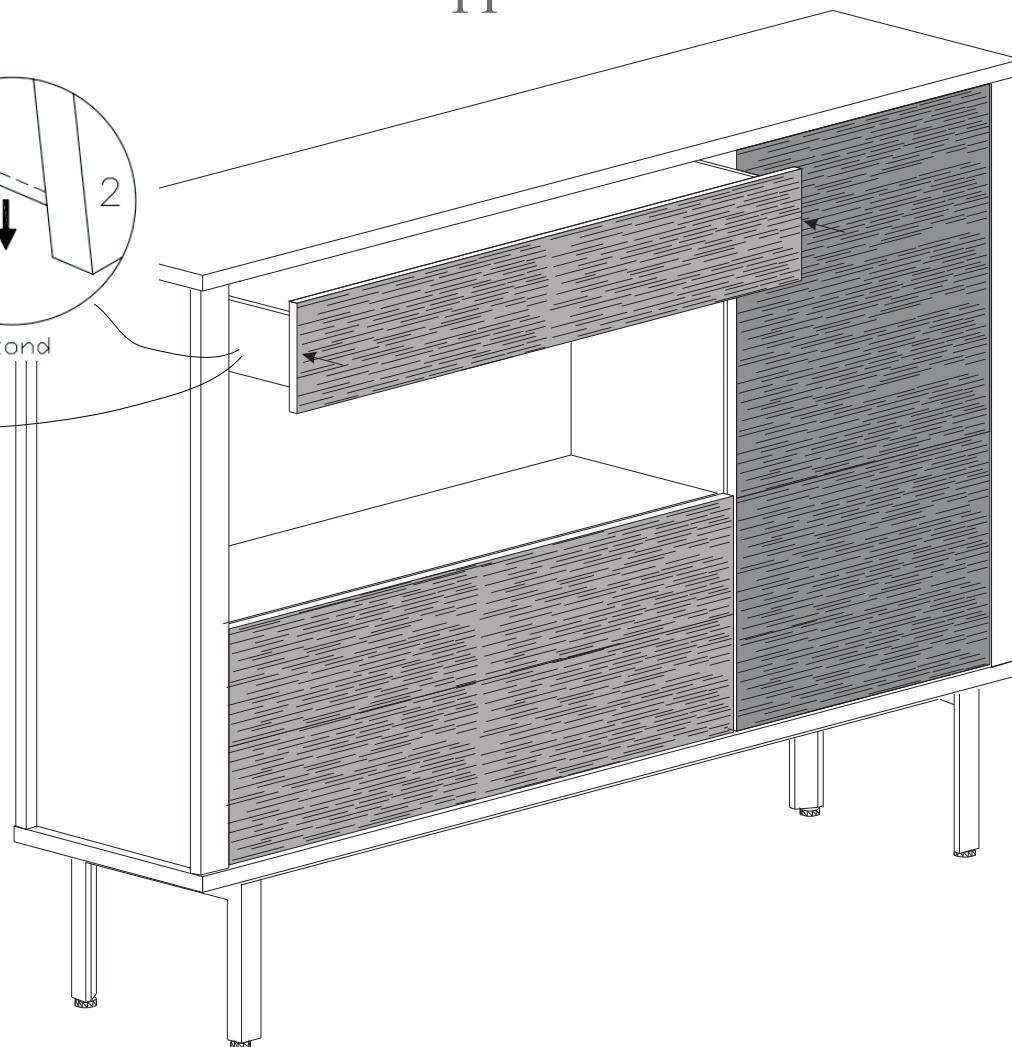

M8X16 M5 \varnothing 15X15 \varnothing 10X40 M4X16 门吸 M6X16 内嵌铰链 下翻气撑 \varnothing 5 M350 M4X25 \varnothing 12X15 \varnothing 6X30 M4

A B C D E F G H I J K L M N O